

## NPN General Purpose Transistors

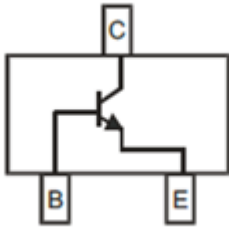

**SOT-23**

### Features

- Epoxy meets UL-94 V-0 flammability rating and halogen free
- Moisture Sensitivity Level 1
- Part no. with suffix "Q" means AEC-Q101 qualified

### Applications

- General purpose switching and amplification

### Mechanical Data

- **Case:** SOT-23
- **Terminals:** Tin plated leads, solderable per J-STD-002 and JESD22-B102
- **Marking:**

BC846AQ=1A	BC847AQ=1E	BC848AQ=1J
BC846BQ=1B	BC847BQ=1F	BC848BQ=1K
	BC847CQ=1G	BC848CQ=1L

### ■ Maximum Ratings (Ta=25°C unless otherwise noted)

Item	Symbol	Unit	Conditions	Value	
Collector-Base Voltage	$V_{CBO}$	V		BC846AQ、BC846BQ	80
				BC847AQ、BC847BQ、 BC847CQ	50
				BC848AQ、BC848BQ、 BC848CQ	30
Collector-Emitter Voltage	$V_{CEO}$	V		BC846AQ、BC846BQ	65
				BC847AQ、BC847BQ、 BC847CQ	45
				BC848AQ、BC848BQ、 BC848CQ	30
Emitter-Base Voltage	$V_{EBO}$	V		6	
Collector Current -Continuous	$I_C$	A		0.1	
Total Device Dissipation (*)	$P_D$	mW		300	
Thermal Resistance Junction to Ambient (*)	$R_{thJA}$	K/W		417	
Junction Temperature	$T_j$	°C		150	
Storage Temperature	$T_{STG}$	°C		-55 to +150	

(\*) Device mounted on FR-4 PCB 1.0 x 1.0 x 0.06 inch.



# BC846Q THRU BC848Q

## ■ Electrical Characteristics (Ta=25°C unless otherwise noted)

Item	Symbol	Unit	Conditions	Min	Max
Collector-base breakdown voltage	$V_{(BR)CBO}$	V	BC846AQ、BC846BQ	$I_C=10\mu A, I_E=0$	80
			BC847AQ、BC847BQ、 BC847CQ		50
			BC848AQ、BC848BQ、 BC848CQ		30
Collector-emitter breakdown voltage	$V_{(BR)CEO}$	V	BC846AQ、BC846BQ	$I_C=10mA, I_B=0$	65
			BC847AQ、BC847BQ、 BC847CQ		45
			BC848AQ、BC848BQ、 BC848CQ		30
Emitter-base breakdown voltage	$V_{(BR)EBO}$	V	$I_E=10\mu A, I_C=0$	6	
Collector cut-off current	$I_{CBO}$	nA	BC846AQ、BC846BQ	$V_{CB}=70V, I_E=0$	100
			BC847AQ、BC847BQ、 BC847CQ	$V_{CB}=50V, I_E=0$	
			BC848AQ、BC848BQ、 BC848CQ	$V_{CB}=30V, I_E=0$	
Collector cut-off current	$I_{CEO}$	nA	BC846AQ、BC846BQ	$V_{CE}=60V, I_B=0$	100
			BC847AQ、BC847BQ、 BC847CQ	$V_{CE}=45V, I_B=0$	
			BC848AQ、BC848BQ、 BC848CQ	$V_{CE}=30V, I_B=0$	
Emitter cut-off current	$I_{EBO}$	nA	$V_{EB}=5V, I_C=0$		100
DC current gain	$h_{FE}$		BC846AQ、BC847AQ、 BC848AQ	$V_{CE}=5.0V, I_C=2mA$	110
			BC846BQ、BC847BQ、 BC848BQ		200
			BC847CQ、BC848CQ		420
Collector-emitter saturation voltage	$V_{CE(sat)}$	V	$I_C=100mA, I_B=5mA$		0.5
Base-emitter saturation voltage	$V_{BE(sat)}$	V	$I_C=100mA, I_B=5mA$		1.1
Transition frequency	$f_T$	MHz	$V_{CE}=5V_{dc}, I_C=10mA, f=30MHz$	150	
Collector output capacitance	$C_{ob}$	pF	$V_{CB}=10V, f=1MHz$		4.5

## ■ Ordering Information (Example)

PREFERRED P/N	PACKING CODE	UNIT WEIGHT(g)	MINIMUM PACKAGE(pcs)	INNER BOX QUANTITY(pcs)	OUTER CARTON QUANTITY(pcs)	DELIVERY MODE
BC846AQ、BC846BQ BC847AQ、BC847BQ、BC847CQ BC848AQ、BC848BQ、BC848CQ	F2	Approximate 0.01	3000	30000	120000	7" reel



# BC846Q THRU BC848Q

## Characteristics (Typical)

Fig. 1-Static Characteristic

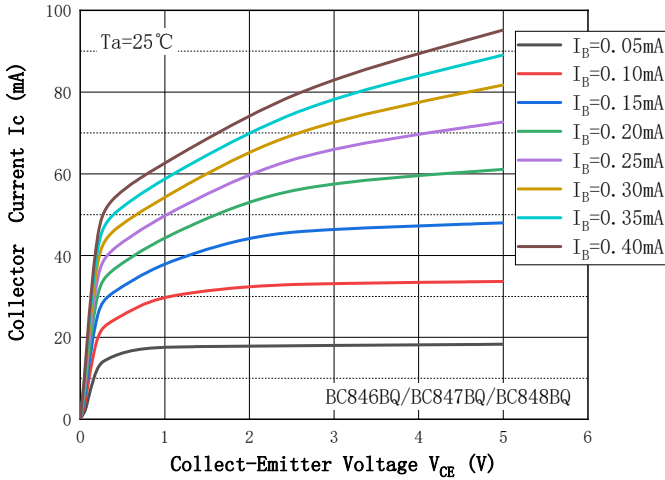

Fig. 2 - DC Current Gian

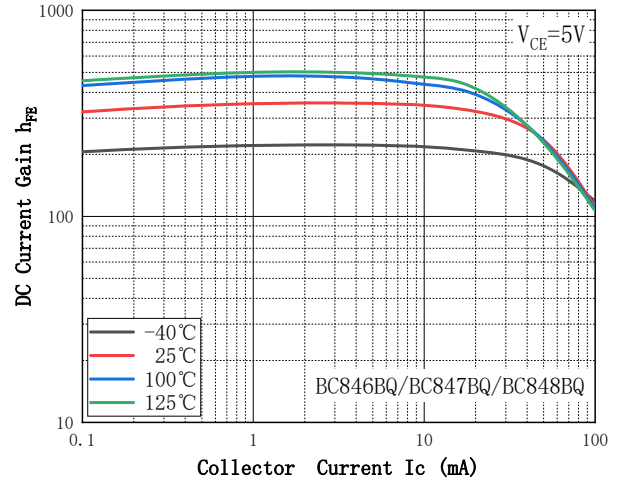

Fig. 3-Static Characteristic

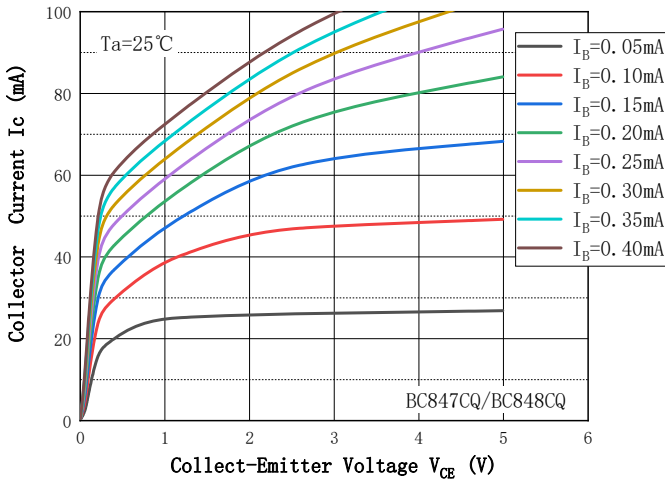

Fig. 4 - DC Current Gian

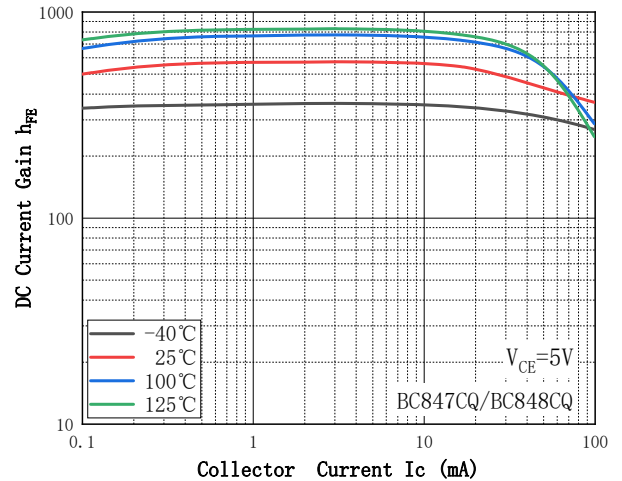

Fig. 5 - Collect-Emittor Saturation Voltage

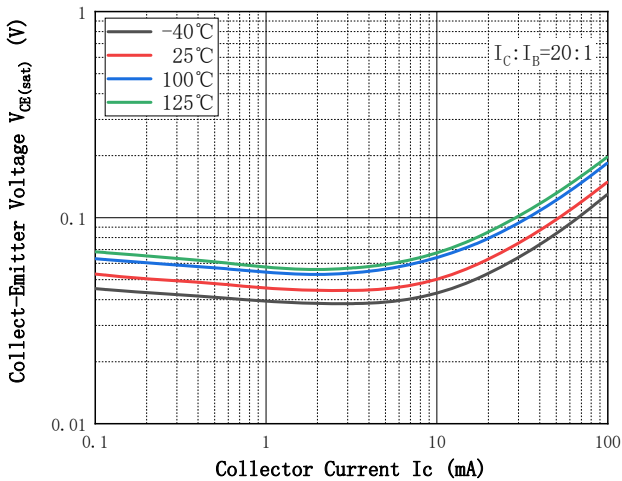
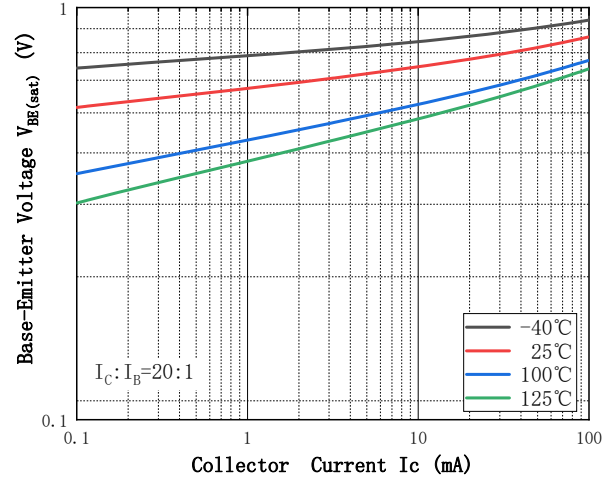

Fig. 6 - Base-Emittor Voltage





# BC846Q THRU BC848Q

Fig. 7 - Base-Emitter On Voltage

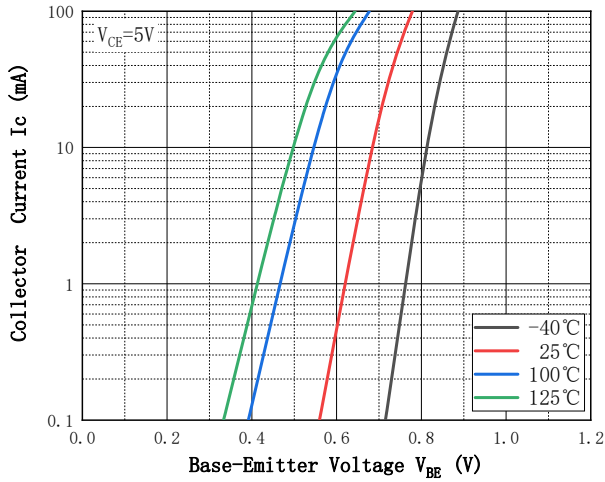
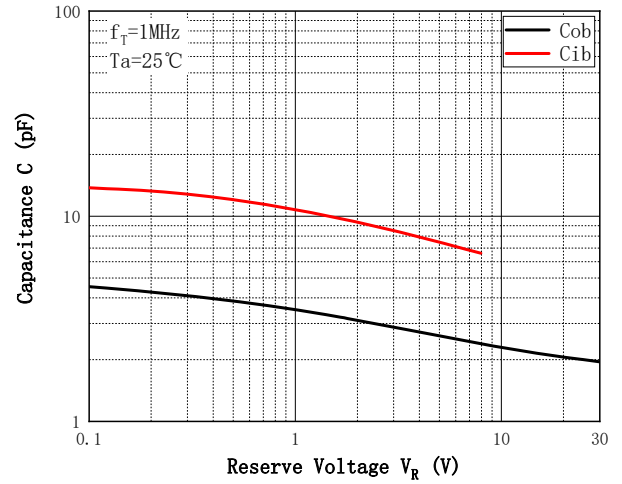
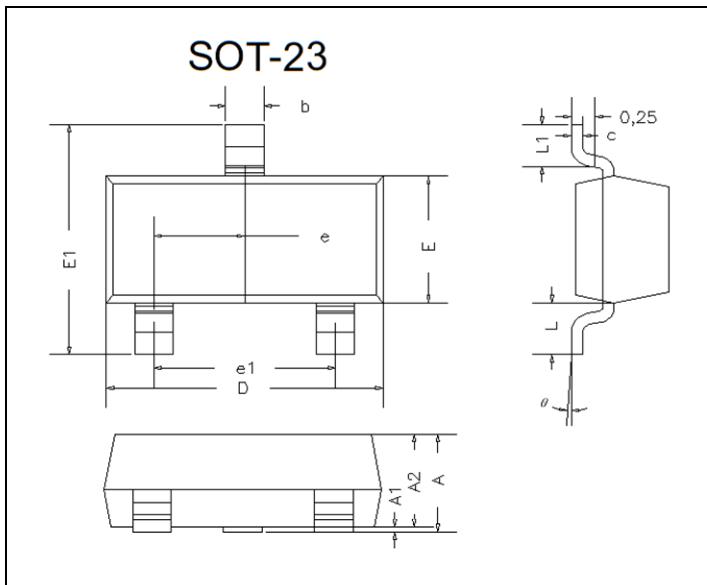

Fig. 8 -  $C_{ob}/C_{ib} - V_{CB}/V_{EB}$



## ■ SOT-23 Package Outline Dimensions



DIM	INCHES		MM		NOTE
	MIN	MAX	MIN	MAX	
A	0.035	0.045	0.90	1.15	
A1	0.000	0.004	0.00	0.10	
A2	0.035	0.041	0.90	1.05	
b	0.012	0.020	0.30	0.50	
c	0.004	0.008	0.10	0.20	
D	0.110	0.118	2.80	3.00	
E	0.047	0.055	1.20	1.40	
E1	0.089	0.100	2.25	2.55	
e	0.370TYP		0.95TYP		
e1	0.071	0.079	1.80	2.00	
L	0.220REF		0.55REF		
L1	0.012	0.020	0.30	0.50	
$\theta$	0°	8°	0°	8°	

## ■ SOT-23 Suggested Pad Layout

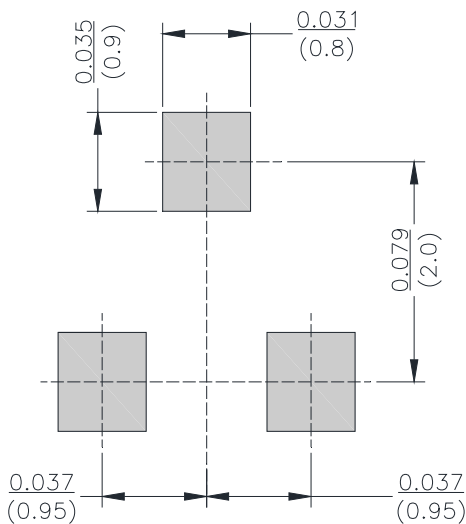

Unit:  $\frac{\text{inch}}{\text{mm}}$



## ■ Marking Information

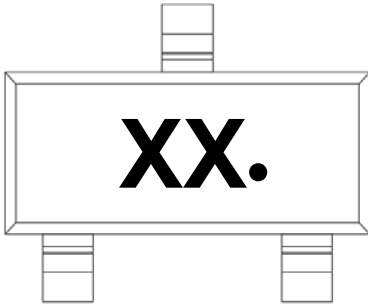

**Note:**

1. All marking is at middle of the product body
2. All marking is in laser marking
3. XX is Marking Code
4. Body color: Black



## BC846Q THRU BC848Q

---

### Disclaimer

The information presented in this document is for reference only. Yangzhou Yangjie Electronic Technology Co., Ltd. reserves the right to make changes without notice for the specification of the products displayed herein to improve reliability, function or design or otherwise.

The product listed herein is designed to be used with automotive electronics, are not designed for use in medical, life-saving, lifesustaining, or military, Yangjie or anyone on its behalf, assumes no responsibility or liability for any damages resulting from such improper use of sale.

This publication supersedes & replaces all information previously supplied. For additional information, please visit our website [http:// www.21yangjie.com](http://www.21yangjie.com) , or consult your nearest Yangjie's sales office for further assistance.